



ProCoder™)R900i™
Installation and Maintenance Guide



ProCoder™)R900i™
Installation and Maintenance Guide

Copyright

This manual is an unpublished work and contains the trade secrets and confidential information of Neptune Technology Group, which are not to be divulged to third parties and may not be reproduced or transmitted in whole or part, in any form or by any means, electronic or mechanical for any purpose, without the express written permission of Neptune Technology Group Inc. All rights to design or inventions disclosed herein, including the right to manufacture, are reserved to Neptune Technology Group Inc.

Neptune engages in ongoing research and development to improve and enhance its products. Therefore, Neptune reserves the right to change product or system specifications without notice.

Trademarks Used in this Manual

N_SIGHT, ProCoder, ProCoder)R900*i*, and ProRead are trademarks of Neptune Technology Group Inc. HP PROTECTUS III, T-10, TRU/FLO, R900, and R900 Gateway are registered trademarks of Neptune Technology Group Inc. Other brands or product names are trademarks or registered trademarks of their respective holders.

FCC Conformity

This device complies with Part 15 of the FCC Rules. Operation is subject to the following two conditions: (1) this device may not cause harmful interference, and (2) this device must accept any interference received, including interference that may cause undesired operation.

NOTE: This equipment has been tested and found to comply with the limits for a Class B digital device, pursuant to Part 15 of the FCC Rules. These limits are designed to provide reasonable protection against harmful interference in a residential installation. This equipment generates, uses, and can radiate radio frequency energy and, if not installed and used in accordance with the instructions, may cause harmful interference to radio communications. However, there is no guarantee that interference will not occur in a particular installation. If this equipment does cause harmful interference to radio or television reception, which can be determined by turning the equipment off and on, the user is encouraged to try to correct the interference by one or more of the following measures:

- Reorient or relocate the receiving antenna.
- Increase the separation between the equipment and receiver.
- Connect the equipment into an outlet on a circuit different from that to which the receiver is connected.
- Consult the dealer or an experienced radio / TV technician for help.

RF Exposure Information

This equipment complies with the FCC RF radiation requirements for uncontrolled environments. To maintain compliance with these requirements, the antenna and any radiating elements should be installed to ensure that a minimum separation distance of 20 cm is maintained from the general population.



Changes or modifications not expressly approved by the party responsible for compliance could void the user's authority to operate the equipment.

Professional Installation

In accordance with Section 15.203 of the FCC rules and regulations, the MIU must be professionally installed by trained utility meter installers. Changes or modifications not expressly approved by the party responsible for compliance could void the user's authority to operate the equipment.

Industry Canada

This Class B digital apparatus meets all requirements of the Canadian Interference Causing Equipment Regulations. Operation is subject to the following two conditions: (1) this device may not cause harmful interference, and (2) this device must accept any interference received, including interference that may cause undesired operation.

Cet appareillage numérique de la classe B répond à toutes les exigences de l'interférence canadienne causant des règlements d'équipement. L'opération est sujette aux deux conditions suivantes: (1) ce dispositif peut ne pas causer l'interférence nocive, et (2) ce dispositif doit accepter n'importe quelle interférence reçue, y compris l'interférence qui peut causer l'opération peu désirée.

ProCoder™)R900i™
Installation and Maintenance Guide
Literature No. IM ProCoder)R900i 01.19
Part No. 13707-001

Neptune Technology Group Inc.
1600 Alabama Highway 229
Tallassee, AL 36078
Tel: (800) 633-8754
Fax: (334) 283-7293

Copyright © 2006 - 2019
Neptune Technology Group Inc.
All Rights Reserved

This page intentionally left blank.

Chapter 1: Product Description	1
Overview	1
ProCoder™)R900i™ Programming	2
Chapter 2: Specifications	3
Electrical Specifications	3
Transmitter Specifications	3
Environmental Conditions	3
Functional Specifications	3
Dimensions and Weight	4
ProCoder™)R900i™ Dimensions	4
Chapter 3: Reading the ProCoder™)R900i™	7
How to Read	7
Common Causes of Leaks	8
How to Tell if Water is in Use	9
If Continuous Leak is Repaired	9
If Intermittent Leak is Repaired	9
Chapter 4: Installing the ProCoder™)R900i™	11
Prior to Installation	11
Storage	11
Unpacking	11
Site Selection	12
Installing the ProCoder™)R900i™	12
New Meter Installation	12
Retrofit Meter Installation	13
Connecting the ProCoder™)R900i™ Through-the-Lid Antenna	14
Installing the Antenna	14
Attaching the Antenna to the MIU	16
Chapter 5: Data Logging Extraction	19
About Data Logging	19

Accessing Data Logging	19
Initializing the Data Logger	21
Initiating RF-Activated Data Logging	24
Sample Data Logging Graphs	26
Off-Cycle Data Extraction	27
Belt Clip Transceiver	28
<i>Chapter 6: Troubleshooting</i>	<i>29</i>
Possible Reading Values	29
<i>Chapter 7: Contact Information</i>	<i>31</i>
By Phone	31
By Fax	31
By Email	31
<i>Appendix A: ProCoder™R900i™ Flags</i>	<i>33</i>
Description of Flags	33
Zero Consumption Flag	34
<i>Glossary</i>	<i>35</i>
<i>Index</i>	<i>39</i>

Figure 1 – ProCoder™)R900i™	2
Figure 2 – ProCoder™)R900i™ Dimensions	4
Figure 3 – ProCoder™)R900i™ Antenna Dimensions	5
Figure 4 – ProCoder™ Face and Sweep Hand	7
Figure 5 – ProCoder™)R900i™ Installation	11
Figure 6 – ProCoder™)R900i™ Antenna	14
Figure 7 – Through-the-Lid Antenna	14
Figure 8 – Locking the Nut on the Antenna	15
Figure 9 – Securing the Locking Nut	15
Figure 10 – Installation Complete	15
Figure 11 – Removing the Dust Cover	16
Figure 12 – Aligning the F Connector	16
Figure 13 – Connecting the Coaxial Cable	17
Figure 14 – HHU Home Screen	19
Figure 15 – N_SIGHT™ Menu	20
Figure 16 – Data Logger Option	20
Figure 17 – Reader ID Input	21
Figure 18 – HHU Time Confirmation	21
Figure 19 – Initializing RF Device	22
Figure 20 – Entering MIU ID	22
Figure 21 – Capture Button	23
Figure 22 – Meter Size Selection	23
Figure 23 – Start Button	24
Figure 24 – Listening for Data	24
Figure 25 – Receiving Data	25
Figure 26 – Graph Button	25
Figure 27 – Examples of Data Logging Graphs	26
Figure 28 – HHU Home Screen	27

Figure 29 – HHU Menu27

Figure 30 – Off-Cycle Option28

Table 1 – Transmitter Specifications	3
Table 2 – Environmental Conditions	3
Table 3 – Functional Specifications	3
Table 4 – Dimensions and Weight	4
Table 5 – Possible Leaks	8
Table 6 – Data Logging Graph Legend	26
Table 7 – Reading Value Examples	29
Table 8 – Eighth-Digit Resolution by Meter Size	33
Table 9 – Backflow Flag	33
Table 10 – Leak Status Flag	34

This page intentionally left blank.

Overview

This chapter provides a general description of the ProCoder™)R900i™ register. The Neptune® ProCoder)R900i is an integrated meter-reading register that contains both the ProCoder™ and R900® technologies in one register that transmits the data that a meter reader collects. A Neptune walk-by, mobile, R900® Gateway fixed network data collection system, or LoRa® fixed network collection system receives the data and stores it to download into the utility billing system for processing.

The ProCoder)R900i is easily installed and operates within a radio frequency (RF) band which does not require an operating license. The ProCoder)R900i meets Federal Communications Commission (FCC) regulations Part 15.247 allowing higher output power and greater range. The ProCoder)R900i uses frequency-hopping spread-spectrum technology to avoid RF interference and enhance security. The transmitted data is updated at 15-minute intervals and transmits a mobile message that includes the meter reading data and the unique ProCoder)R900i ID every 14 to 20 seconds. This allows a Hand-Held Unit (HHU) or mobile data collections unit to read the meter.

The ProCoder)R900i also transmits a high-power fixed network message every seven and one-half minutes on an interleaved basis to an R900 Gateway. If connected to a LoRa network, the ProCoder)R900i can also transmit time-synchronized, hourly readings every three hours on an interleaved basis to a LoRa network.

The ProCoder)R900i offers advantages to utility organizations of all sizes:

- Increases meter reading accuracy
- Eliminates hard-to-read meters
- Protects utility liability by increasing meter reader safety
- Requires no external wiring or programming
- Provides enhanced eight-digit Automated Meter Reading (AMR)
- Provides proactive customer service benefits (leak, tamper, and backflow detection)



Figure 1 – ProCoder™)R900i™

ProCoder™)R900i™ Programming

The ProCoder)R900i is NOT field-programmable. At the factory, each of the following items is programmed into the meter interface unit (MIU):

- Serial number – Each MIU is given a unique serial number / identification number
- Meter size and change gear information

This chapter provides the specifications for the ProCoder™)R900i™.

Electrical Specifications

The ProCoder)R900i is powered by a lithium battery.

Transmitter Specifications

Table 1 – Transmitter Specifications

Specification	Description
Transmit Period	<ul style="list-style-type: none"> • Every 14 to 20 seconds (standard R900® mobile message) • Every seven and one-half minutes (standard R900 fixed network message) • Every three hours (standard LoRa® fixed network message)
Transmitter Channels	50 (R900 mobile and fixed) and 64 (LoRa fixed network message)
Channel Frequency	902-928 MHz
Output Power	Meets FCC Part 15.247
FCC Verification	Part 15.247

Environmental Conditions

Table 2 – Environmental Conditions

Condition	Description
Operating Temperature	-22° to 149°F (-30° to 65°C)
Storage Temperature	-40° to 158°F (-40° to 70°C)
Operating Humidity	0 to 100% condensing (pit only)

Functional Specifications

Table 3 – Functional Specifications

Specification	Description
Register Reading	<ul style="list-style-type: none"> • Eight digits (AMR) • Eight digits (Visual)
MIU ID	<ul style="list-style-type: none"> • 10 digits (R900 v4) • Nine digits (R900 v5)

Dimensions and Weight

Table 4 – Dimensions and Weight

Measurement	Description
Dimensions	Refer to Figure 2 and Figure 3 on page 5.
Weight	<ul style="list-style-type: none"> • Inside – 1.39 lbs. (630.5 grams) • Pit – 1.62 lbs. (734.8 grams)

ProCoder™)R900i™ Dimensions

The following diagrams show both the inside and pit dimensions for the ProCoder)R900i.

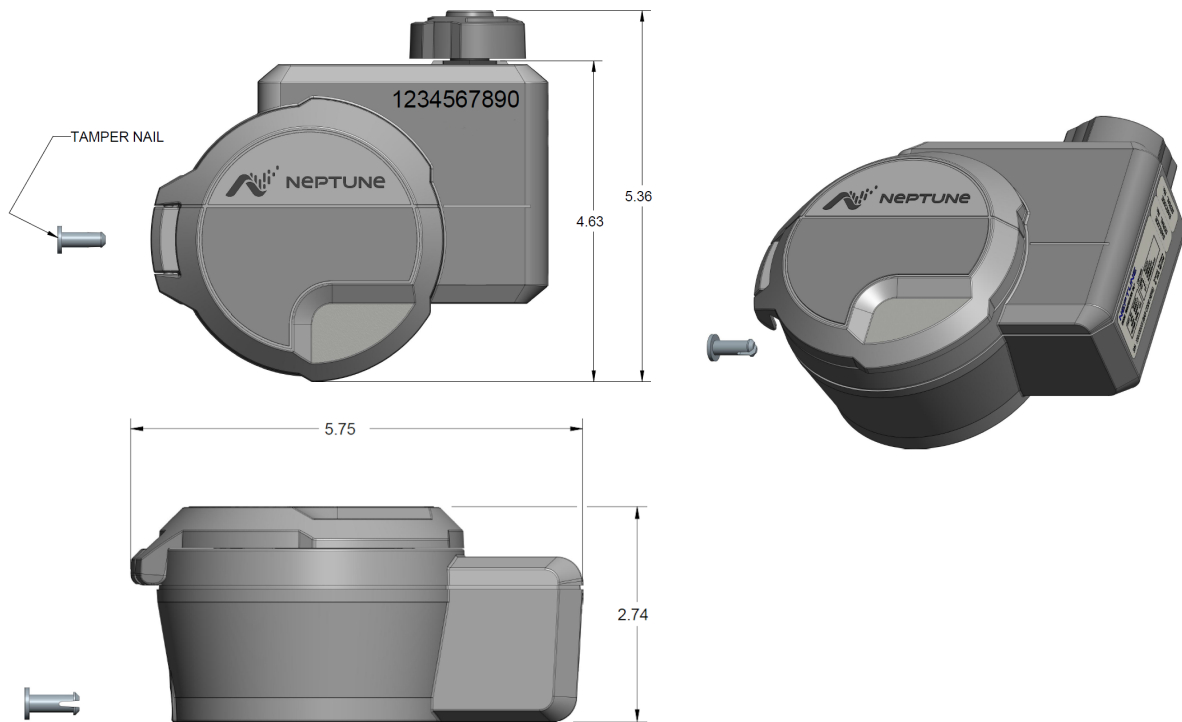

Figure 2 – ProCoder™)R900i™ Dimensions

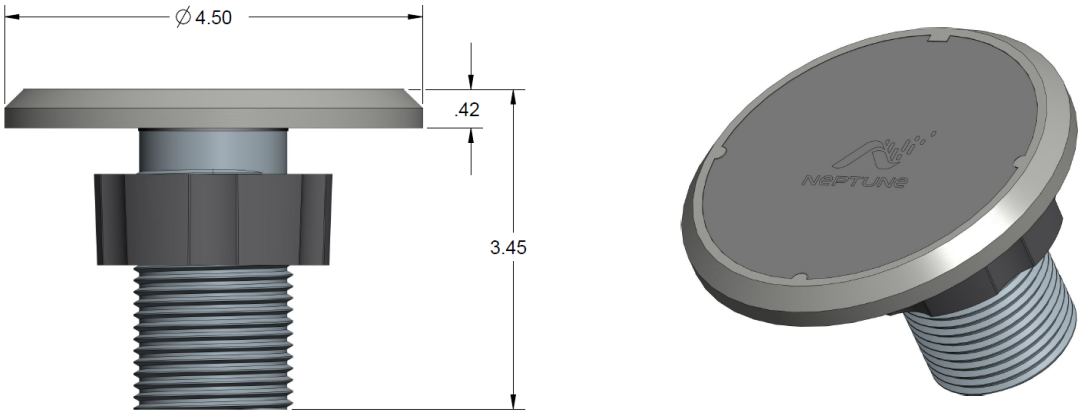

Figure 3 – ProCoder™)R900i™ Antenna Dimensions

This page intentionally left blank.

Chapter 3: Reading the ProCoder™)R900i™

This chapter provides information on reading the ProCoder™)R900i™.

How to Read

Become familiar with the information available from the meter.

Example: 5/8" T-10

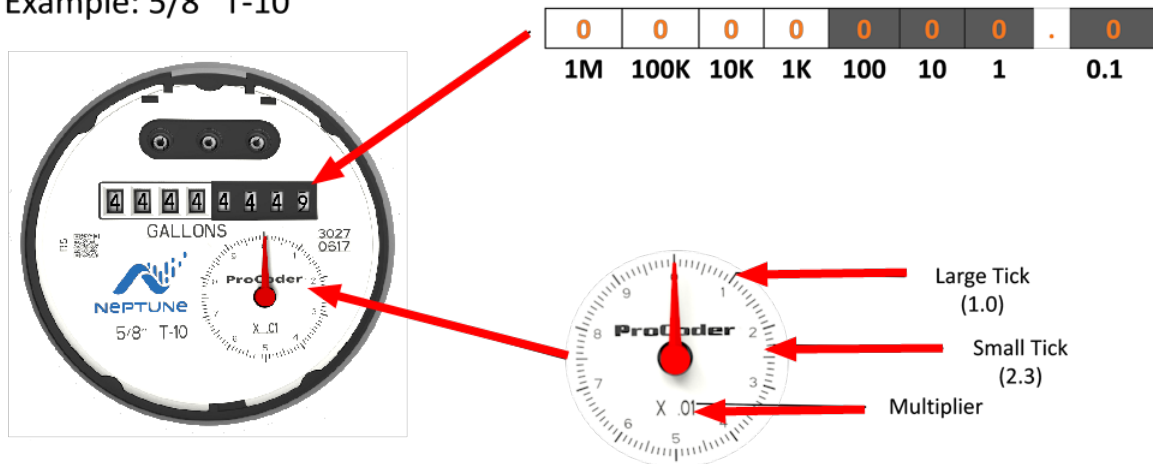

Figure 4 – ProCoder™ Face and Sweep Hand

The sensitive sweep hand provides a visual representation of extreme low flows as well as reverse flows. Depending on the size and type of ProCoder register, a specific multiplier is present. This multiplier, along with the current position of the sweep hand, provides additional digits of resolution that are especially useful for testing.



For further information on reading the ProCoder sweep hand, see the Product Support Document *How to Read the Neptune ProCoder™ Register*.

Common Causes of Leaks

Leaks can result from various circumstances. The following table contains some common causes of leaks.

Table 5 – Possible Leaks

Possible Cause of Leak	Intermittent Leak	Continuous Leak
Outside faucet, garden, or sprinkler system leaking	✓	✓
Toilet valve not sealed properly	✓	✓
Toilet running		✓
Faucet in kitchen or bathrooms leaking	✓	✓
Ice maker leaking		✓
Soaker hose in use		✓
Leak between the water meter and the house		✓
Washing machine leaking	✓	✓
Dishwasher leaking	✓	✓
Hot water heater leaking		✓
Watering yard for more than eight hours	✓	✓
Continuous pet water device in use		✓
Water-cooled air conditioner or heat pump	✓	✓
Swimming pool filled		✓
Any continuous use of water for 24 hours		✓

Check all equipment that uses water to determine where the leak originates.

How to Tell if Water is in Use

To determine if water is in use, complete the following steps:

1. View the mechanical sweep hand.
2. Determine the following conditions. If the sweep hand is:
 - Moving slowly in a clockwise direction, water is running very slowly
 - Moving quickly, water is running
 - Not moving, water is not in use
 - Moving in a counter-clockwise direction, backflow is occurring

If Continuous Leak is Repaired

If you find and repair a continuous leak, complete the following steps:

1. Use no water for at least **15 minutes**.
2. Check the sweep hand.

If the sweep hand is not moving, there is no longer a continuous leak.

If Intermittent Leak is Repaired

If you find and repair an intermittent leak, check the sweep hand after at least **24 hours**.

If the sweep hand is not moving, there is no longer an intermittent leak.

This page intentionally left blank.

Chapter 4: Installing the ProCoder™)R900i™

This chapter describes the installation process for the ProCoder™)R900i™.

Prior to Installation

This section provides information on:

- Storing and unpacking the ProCoder)R900i
- Site selection
- Preliminary tests, tools, and materials needed for installation

Complete these procedures before you install the ProCoder.

Storage

Upon receipt, inspect the shipping containers for damage, and inspect the contents of any damaged cartons prior to storage.

After you inspect the cartons, store them in a clean, dry environment. Ensure the unit is in sleep mode until it is exposed to light.

Unpacking

Handle the ProCoder)R900i carefully; however, no additional special handling is required. When shipped, the assembly is lying on its side. Lift the assembly out of the box by the meter maincase.

After unpacking the ProCoder)R900i, inspect it for damage. If the ProCoder)R900i appears to be damaged or proves to be defective upon installation, notify your Neptune Territory Manager or Distributor. If one or more items requires reshipment, use the original cardboard box and packing material.



Figure 5 – ProCoder™)R900i™ Installation

Site Selection

Installation and operation in moderate temperatures increases reliability and product life. See "Environmental Conditions" on page 3.

Follow these guidelines when selecting a location to install the ProCoder)R900i:

- Install the ProCoder)R900i in a vertical and upright position.
- Clear the selected location of all obstructions.



Always follow your company's safety practices and installation guidelines when installing a ProCoder)R900i. Never perform an installation during a lightning storm or under excessively wet conditions.

Installing the ProCoder™)R900i™

Follow the steps in this section to install the ProCoder)R900i.

New Meter Installation

1. Flush the service line prior to installing the meter to remove debris in the line.
2. Place an electrical grounding strap on the service line, connecting the inlet and outlet service lines on either side of the meter setting.



You must install the inlet and outlet meter valves and couplings / setters, if they are not already present. Allow appropriate space in the line for the meter laying length and two coupling gaskets. Align the pipe ends so that the coupling and meter threads can engage without binding or cross-threading.

3. Before installing the meter, remove the thread protectors and spud caps. Be sure that no debris enters the meter during installation.



Use caution; the meter threads are sharp.

4. Place the coupling gaskets inside the coupling nuts and set the meter in the line. Align the meter in a horizontal position with the register dial facing upward. The direction of flow marked on the meter must agree with the direction of actual water flow.
5. Tighten the coupling nuts by hand then use a wrench and tighten sufficiently to prevent leakage. Be careful not to cross-thread the connections.
6. Open the meter outlet valve slowly. Open a downstream faucet and run enough water to dissipate entrained air and flush the line. While the faucet is open, verify the meter is operating correctly.
7. Turn off the faucet and check the meter installation for leaks. See "Reading the ProCoder™)R900i™" on page 7

Retrofit Meter Installation

1. Use a punch / screwdriver and hammer to punch out the tamper-proof seal pin on the existing register head.
2. Remove the existing register by twisting counter-clockwise.
3. Install the new ProCoder)R900i register head onto the meter body in the desired orientation by twisting clockwise.
4. Snap the new tamper-proof seal pin to secure the register to the meter body.

Connecting the ProCoder™)R900i™ Through-the-Lid Antenna

When ordering an external antenna for the ProCoder)R900i unit, Neptune recommends at least a **6-foot cable** to allow for easy removal of the pit lid when necessary.



Figure 6 – ProCoder™)R900i™ Antenna

Installing the Antenna

To install the antenna, complete the following steps.

1. Insert the antenna cable and housing through the 1¾-inch hole in the meter pit lid.



Figure 7 – Through-the-Lid Antenna

2. Thread the locking nut onto the antenna (smooth end towards lid).



Figure 8 – Locking the Nut on the Antenna

3. Hand tighten the nut securely to the lid.



Figure 9 – Securing the Locking Nut

Figure 10 shows a completed installation of the antenna.



Figure 10 – Installation Complete

Attaching the Antenna to the MIU

1. Remove the protective cap and gasket.



If you are replacing an existing antenna, remove the existing antenna connection. Clean any dirt, debris, or dielectric grease from the F connector on the MIU housing.



Figure 11 – Removing the Dust Cover

2. Carefully align the F connector center conductor, and insert the antenna connector into the three-lobed black plastic latch plate on the MIU housing.



Figure 12 – Aligning the F Connector

3. Push in and turn clockwise until the antenna connector is properly seated on the three-lobed black plastic latch plate.



Figure 13 – Connecting the Coaxial Cable

This page intentionally left blank.

Chapter 5: Data Logging Extraction

This chapter provides information about data logging.

About Data Logging

The ProCoder™R900i™ stores interval data for data logging and retrieving this data through RF activation. You activate the ProCoder)R900i using the Trimble® Nomad® and R900® Belt Clip Transceiver (BCT).

The ProCoder)R900i stores consumption in hourly intervals for a rolling total of 96 days, which is equal to 2,304 hourly intervals of consumption. The logged data can be extracted through radio frequency (RF) activation. The RF activation allows the utility workers to visit the location and extract the data without physically interacting with the meter itself. This limits worker exposure to animals or dangerous situations. The extraction process only takes about 30 seconds. You activate the unit through the Hand-Held Unit (HHU) connected to the R900 BCT via Bluetooth®. The R900 BCT sends the activation signal to the ProCoder)R900i which in turn sends the data intervals to the R900. The data is saved in the HHU.

Accessing Data Logging

Complete the following steps to log data.

1. From the host software home screen on the HHU, click **MENU**.



Figure 14 – HHU Home Screen

- From the HHU Menu screen, click UTILS (option 4).

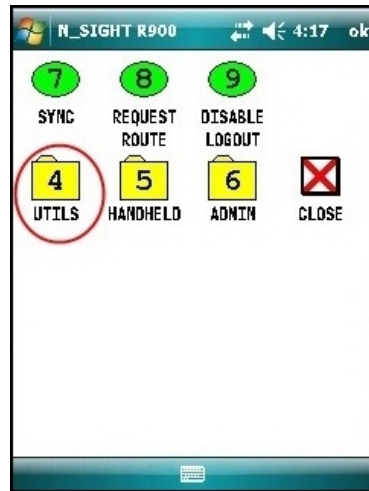

Figure 15 – N_SIGHT™ Menu

- Click DATA LOGGER (option 9).

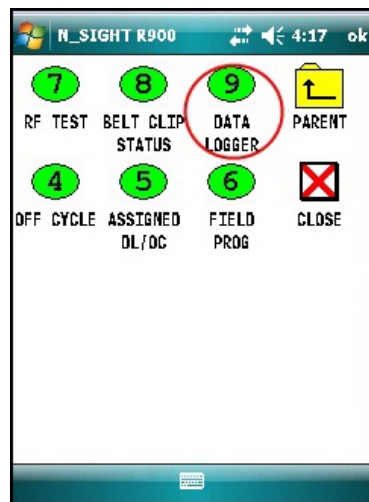

Figure 16 – Data Logger Option

4. Type your reader ID and password (if applicable) for the host software, and then click **LOGIN**.

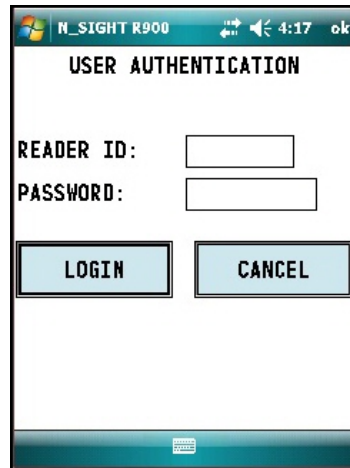

Figure 17 – Reader ID Input

Initializing the Data Logger

1. Verify the time is correct, and then click **YES**.

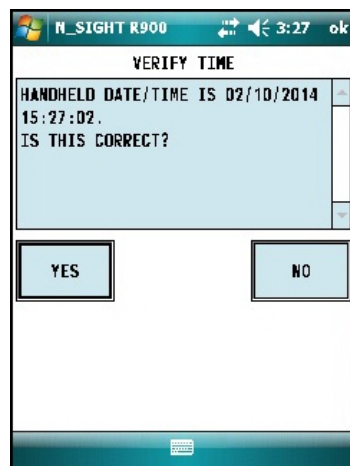

Figure 18 – HHU Time Confirmation



Synchronize the HHU prior to data logging to set the clock.

The Initialize screen appears if you are not connected or you are not in range of your R900 BCT.

2. Click INITIALIZE.

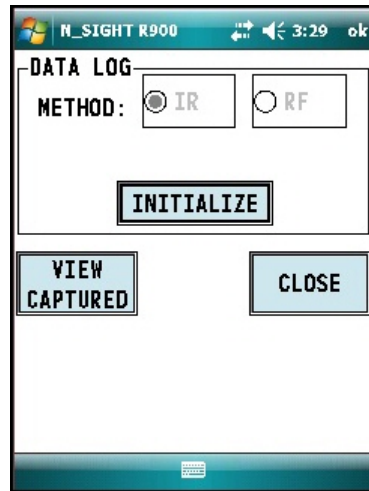

Figure 19 – Initializing RF Device

3. Select RF and type the MIU ID.

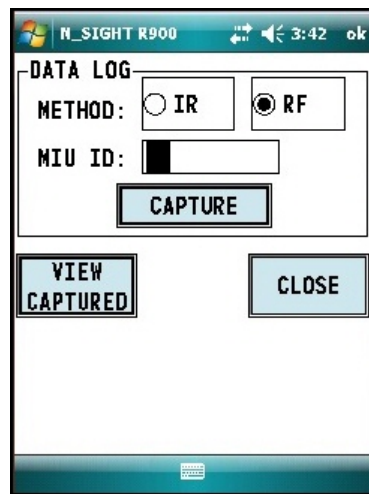

Figure 20 – Entering MIU ID

- After you type the MIU ID, click **CAPTURE**.

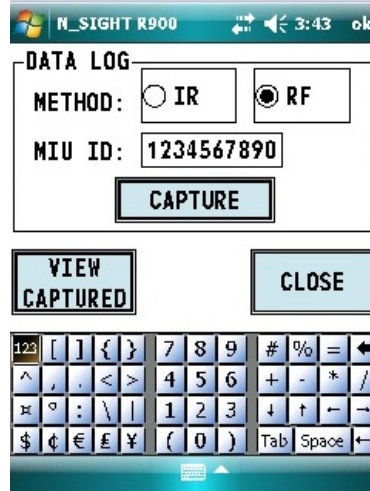

Figure 21 – Capture Button

A prompt appears for you to provide meter size and unit of measure.

- Type or select the field information, and then click **OK**.

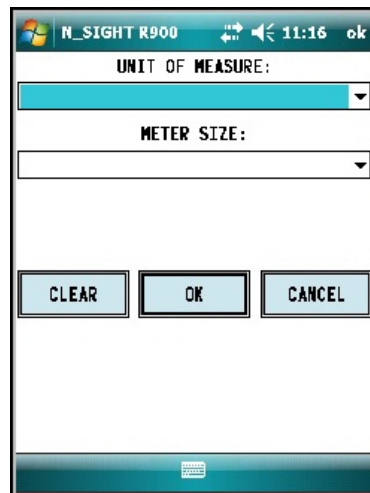

Figure 22 – Meter Size Selection

Initiating RF-Activated Data Logging

1. Click **START** to initiate RF-activated data logging.

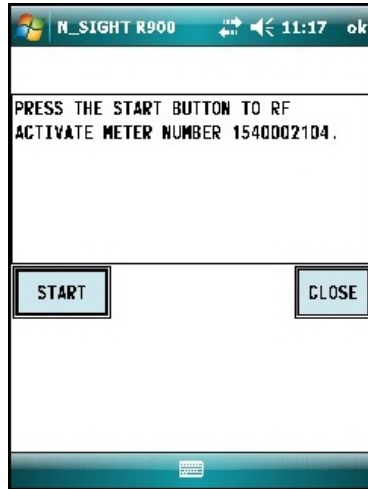

Figure 23 – Start Button

The R900 BCT activates the ProCoder)R900i and listens for the data logger to start transmitting.

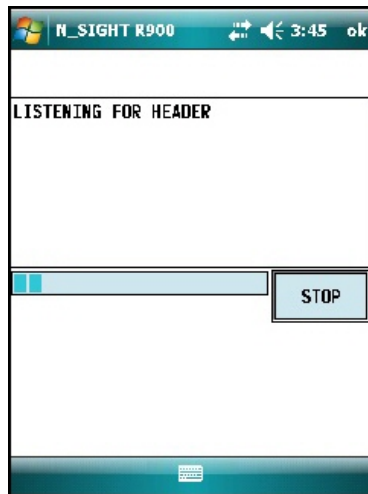

Figure 24 – Listening for Data

The screen displays the data received.

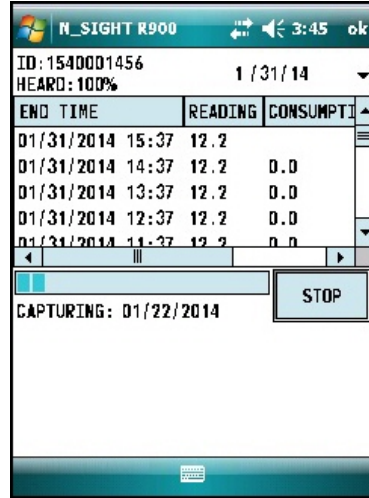

Figure 25 – Receiving Data

2. After the data logging process is completed, choose the meter size. See Figure 22 on page 23.
3. Click **GRAPH** to display the data in a graph. See examples of graphs in Figure 27 on page 26.

The HHU processes and saves the data. After closing the data logging screen, the unit performs a backup.

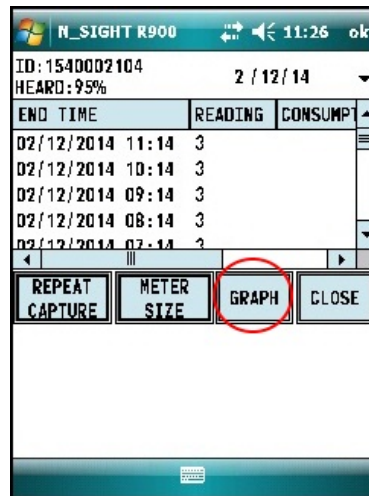

Figure 26 – Graph Button

Sample Data Logging Graphs

The following are two examples of the graphs produced with data logging.

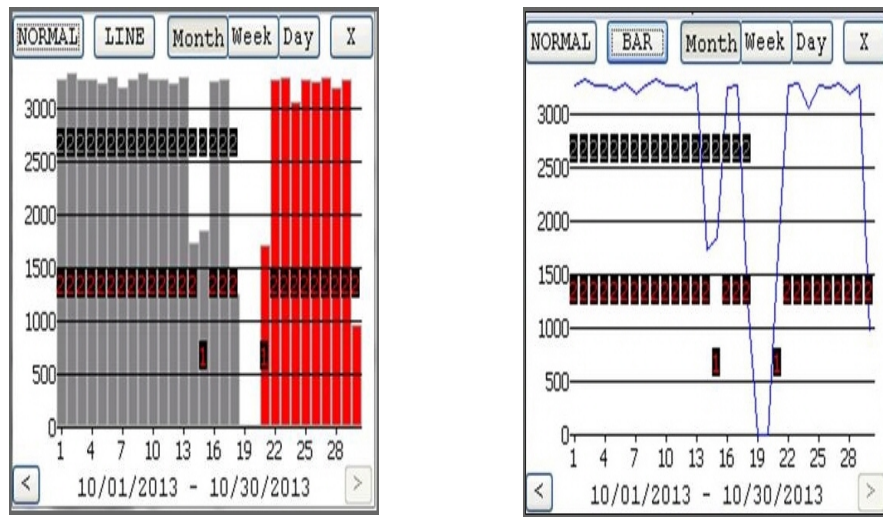

Figure 27 – Examples of Data Logging Graphs

Table 6 – Data Logging Graph Legend

Color Code	Description
1 red bar	Intermittent Leak
2 red bars	Continuous Leak
1 gray bar	Minor Backflow
2 gray bars	Major Backflow
Blue bars	No Flags
Red bars	Leak
Gray bars (If the Backflow flag and Leak flag appear at the same time, the Backflow (gray bars) has precedence over the Leak.	Backflow

Off-Cycle Data Extraction

Off-cycle reads are 96 days of daily reads. This allows the utilities to retrieve move-out reads or monitor vacant usage to prevent theft.

To navigate to the off-cycle function, complete the following steps.

1. From the host software home screen on the HHU, click **MENU**.



Figure 28 – HHU Home Screen

2. From the HHU menu screen, click **UTILS** (option 4).

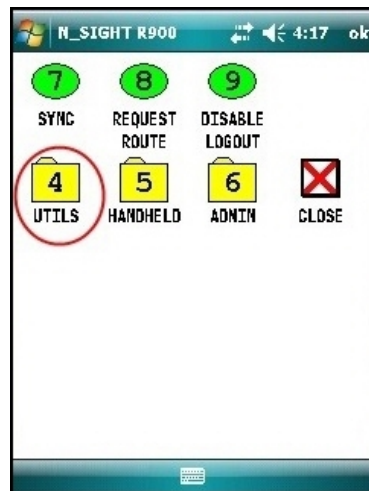

Figure 29 – HHU Menu

3. Click **OFF CYCLE** (option 4).

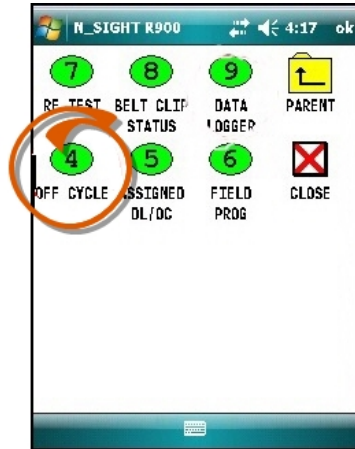

Figure 30 – Off-Cycle Option

4. Type the read ID and the password.
5. Click **LOGIN**.
6. Confirm the date and time are correct.
7. Click **YES**.

Belt Clip Transceiver

To pair the BCT, complete the following steps.

1. Change the date if you have a specific day to target.
2. Click **INITIALIZE** to pair with the R900 BCT.
3. Type the MIU ID.
4. Click **CAPTURE**.

The reads come in just like the data logger reads. The data logger has 96 days of hourly reads and off cycle has 96 days of daily reads.

This chapter takes you through troubleshooting procedures for the ProCoder™)R900/™.

Possible Reading Values

This section provides possible reading values and what they indicate.

Table 7 – Reading Value Examples

Reading Value	Definition	Troubleshooting
.....	Failure to retrieve reading	<ul style="list-style-type: none"> This usually indicates a cut wire. Check the connection between the register and MIU. If using a non-auto-detect ProRead register, verify that it has been programmed for three-wire mode.
???????	Indicates an ambiguous, bad read, replaces ----- and HHHHHHHH	
MMMMMMMM	Indicates out of range reading (>99999999), diagnostic code from the MIU	<ul style="list-style-type: none"> Indicates that no meter reading history is available. Swipe the MIU with a magnet to force the MIU to read the register.
UUUUUUUU	Indicates an undefined out-of-range reading or corrupt valve	

This page intentionally left blank.

Chapter 7: Contact Information

Within North America, Neptune Customer Support is available Monday through Friday, 7:00 A.M. to 5:00 P.M. Central Standard Time by telephone, email, or fax.

By Phone

To contact Neptune Customer Support by phone, complete the following steps.

1. Call (800) 647-4832.
2. Select one of the following options:
 - Press **1** if you have a Technical Support Personal Identification Number (PIN).
 - Press **2** if you do not have a Technical Support PIN.
3. Type the six-digit PIN and press **#**.
4. Select one of the following options.
 - Press **2** for Technical Support.
 - Press **3** for maintenance contracts or renewals.
 - Press **4** for Return Material Authorization (RMA) for Canadian accounts.

You are directed to the appropriate team of Customer Support Specialists. The specialists are dedicated to you until the issue is resolved to your satisfaction. When you call, be prepared to give the following information:

- Your name and utility or company name.
- A description of what occurred and what you were doing at the time.
- A description of any actions taken to correct the issue.

By Fax

To contact Neptune Customer Support by fax, send a description of your problem to (334) 283-7497. Please include on the fax cover sheet the best time of day for a Support Specialist to contact you.

By Email

To contact Customer Support by email, send your email message to support@neptunetg.com.

This page intentionally left blank.

Appendix A: ProCoder™)R900i™ Flags

This appendix describes the flags associated with the ProCoder™)R900i™.

Description of Flags

The two tables in this appendix describe the volume represented by the eighth digit by meter size, and the flags the ProCoder)R900i uses.

Table 8 – Eighth-Digit Resolution by Meter Size

Register Size	Eighth-Digit Resolution - Least Significant Digit
Residential (5/8" - 1" T-10®)	1/10 Gallon or 1/100 Cubic foot
Light Commercial and Industrial (1-1/2" and 2" T-10, 1-1/2" - 4" HP Turbine)	1 Gallon or 1/10 Cubic foot
Large Commercial and Industrial (6" - 10" HP Turbine, HP PROTECTUS® III and TRU/FLO®)	10 Gallons or 1 Cubic foot

Table 9 – Backflow Flag

Backflow Flag (resets after 35 days)	
Based on reverse movement of the eighth digit. The eighth digit is variable based on the meter size.	
No backflow event	Eighth digit reversed less than one digit
Minor backflow event	Eighth digit reversed more than one digit, up to 100 times the eighth digit
Major backflow event	Eighth digit reversed greater than 100 times the eighth digit

Table 10 – Leak Status Flag

Leak Status Flag (resets after 35 days)	
Based on total amount of 15-minute periods recorded in the previous 24-hour period.	
No leak	Eighth digit incremented less than 50 of the 96 15-minute intervals
Intermittent leak	Eighth digit incremented in 50-95 of the 96 15-minute intervals
Continuous leak	Eighth digit incremented in all of the 96 15-minute intervals

Zero Consumption Flag

The consecutive days with Zero Consumption Flag (out of rolling 35 days) is the number of days the leak status was at a minimum value.

A

AMR

Automated Meter Reading.

antenna (pit)

The MIU antenna used for pit installations.

B

BCT

The belt clip transceiver.

F

FHSS

Frequency-hopping spread-spectrum.

H

HHU

Hand-Held Unit.

I

inside version

The ProCoder)R900*i* inside version has a laser sealed plastic body.

L

LCD

The Liquid Crystal Display (LCD) is the component where the meter reading and value-added icons are displayed.

M

MIU

The meter interface unit.

P

PIN

Personal Identification Number for technical support.

pit version

The ProCoder)R900*i* pit version has a roll-sealed metal body.

R

register read time

The default time is 15 minutes for all registers. Custom time is not available.

RF

Radio frequency.

RMA

Return Material Authorization.

S

seal pin

The small black plastic nail used to secure the ProCoder)R900i to the meter.

serial number

A unique identification number given to each MIU at the factory. The default value is the last programmed plus one. Custom serial numbers are not available.

spud cap

Orange caps that are placed on the ends of a meter when shipping.

sweep hand

A sensitive dial that provides a visual representation of extreme low flows as well as reverse flows.

T

transmission time

The time between the MIU transmissions. The default value is approximately 20 seconds. Custom time is not available.

This page intentionally left blank.

A

activate, solar panel 7
air conditioner, leaks 8
antenna 5

B

BCT 19, 28

C

common causes of leaks 8
contact customer support 31
coupling
 gaskets 13
 nuts 13

D

damage, in shipping 11
data logging, about 19
defective product 11
dimensions 4
dishwasher, leaks 8

E

environmental conditions 3

F

faucet
 bathroom leaks 8
 kitchen leaks 8

G

garden leaks 8
general description 1

H

handling, unpack 11
heat pump, leaks 8
heating, leaks 8
HHU
 set the clock 21
hose, leaks 8
hot water, leaks 8

I

ice-maker, leaks 8
inspect, ProCoder)R900i 11
installation
 new meter 12
 positioning of MIU 12
 retrofit meter 13
 site selection, guide lines 12

L

leak

- air conditioner 8
- common causes 8
- found 9
- garden 8
- heat pump 8
- heating 8
- hose 8
- hot water 8
- ice-maker 8
- pet feeder 8
- repaired 9
- sprinkler system 8
- swimming pool 8
- toilet 8
- washing machine 8

P

ProCoder)R900i 11

- general description 1
- install inside version 11
- reading 7
- serial number 2
- specification 3
- storage 11
- unpacking 11

R

RF

- band 1

S

- safety practices 12
- serial number 2
- site selection 12
- specifications
 - functional 3
 - transmitter 3
- sprinkler system, leak 8
- storage 11
- support, contact customer support 31
- sweep hand 7,9

T

- toilet leak 8
- Trimble Nomad 19

W

- washing machine, leak 8
- water in use, determine 9
- weight 4



Neptune Technology Group Inc.

1600 Alabama Highway 229
Tallahassee, AL 36078
USA Tel: (800) 633-8754
Fax: (334) 283-7293

Neptune Technology Group

(Canada) Ltd.
7275 West Credit Avenue
Mississauga, Ontario L5N 5M9
Canada Tel: (905) 858-4211
Fax: (905) 858-0428

Neptune Technology Group Inc.

Avenida Ejercito Nacional No 418
Piso 12, Despacho 1203
Colonia Polanco V Sección
C.P. 11560 Delegación, Miguel Hidalgo
Mexico D.F.
Tel: (55) 5203-5708, (55) 5203-4032,
(55) 5203-5294

Online

www.neptunetg.com