



NEPTUNE
TECHNOLOGY GROUP

ProCoder™
Quick Install Guide

1: Product Description

The ProCoder™ is an electronic absolute encoder register designed for use with the Neptune® Automatic Reading and Billing (ARB®) System. This register operates with the Neptune R900® and R450™ Meter Interface Units (MIUs), providing advanced features such as leak, tamper, and backflow detection.

With the ProCoder register, both the homeowner and the utility can use the following features:

- Mechanical wheel bank for an absolute visual reading
- Eight digits for billing
- Sweep hand for extreme low flow detection and directional water flow indication

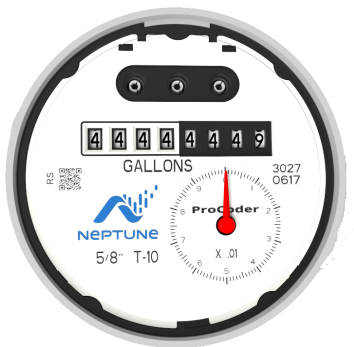

Figure 1: ProCoder™ Dial Face with Sweep Hand

This guide helps you identify and read information displayed on the ProCoder register. It also helps you recognize the common causes of leaks and instructs what to do if you find one. This guide contains steps to determine whether a leak is fixed after repairs.

2: Wiring Inside Set Version

To run a three-conductor cable from the ProCoder™ register to the MIU, complete the following steps.

1. Connect the three-conductor wire to the encoder register's terminals as described in the manufacturer's instructions, using this color code:
 - Black / B
 - Green / G
 - Red / R
2. Remove the terminal cover with a flat-head screw driver.



Figure 2: Removing the Terminal Cover



Figure 3: Wiring with Proper Color Wire

3. Wire the encoder register with the proper colors.
4. Test the wiring to verify the read.

5. Route the wire as shown.



Figure 4: Routing the Wire



Figure 5: Applying Compound

6. Apply Novagard G661 or Down Corning #4 to the terminal screws and exposed bare wires.



Neptune recommends Novagard G661 or Dow Corning Compound #4.



Novagard may cause irritation to eyes and skin. If swallowed, do not induce vomiting; dilute with one to two glasses of water or milk and seek medical attention. Please refer to:

- MSDS Novagard Silicone Compounds & Grease Inc. 5109 Hamilton Ave. Cleveland, OH 44114 216-881-3890.



- For copies of MSDS sheets, call Neptune Customer Support at (800) 647-4832.

3. Place the terminal cover on register, ensuring the wire is routed through the strain relief.



Figure 6: Placing the Cover on the Register



Figure 7: Snapping the Cover in Place

4. Snap the terminal cover in place by pressing on the molded arrow.

3: Wiring the Pit Set Version

To wire the pit set version, complete the steps. Figure 5 shows the components required for installation.



Figure 8: Installation Components

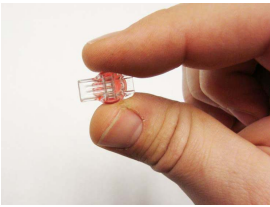

Figure 9: Scotchlok Connector

1. Hold the Scotchlok™ between the index finger and thumb with the red cap facing down.

2. Take one non-stripped black wire from the pigtail and one from the receptacle / MIU and insert the wires into the Scotchlok connector until fully seated.

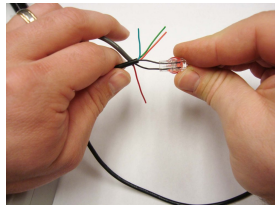

Figure 10: Seating the Connector Wires



Do not strip the colored insulation from the wires or strip and twist the bare wires prior to inserting in the connector. Insert the insulated colored wires directly into the Scotchlok connector.

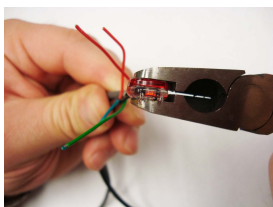

Figure 11: Crimping Tool

3. Place the connector red cap side down between the jaws of the crimping tool. Refer to Table 2 on page 12 for part numbers.

4. Check to ensure that the wires are still fully seated in the connector before crimping the connector. Figure 12 illustrates improper connections due to wires not being fully seated.

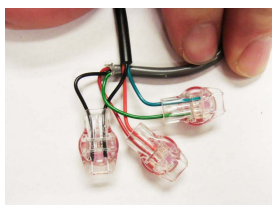

Figure 12: Improper Connections

5. Squeeze the connector firmly with the proper crimping tool until you hear a pop and gel oozes out the end of the connector.
6. Repeat steps 1 through 5 for each color wire. See Table 1 on page 7 for the wiring configuration to connect MIUs to the ProCoder.

Table 1: Color Codes for Wires

MIU Wire Color/ Encoder Terminal	MIU Type
Black / B Green / G Red / R	<ul style="list-style-type: none">• R900• R450
Black / G Green / R Red / B	Sensus
Black / B White / G Red / R	ltron
Black / G White / R Red / B	Aclara
Black / G Green / B Red / R	Elster
Black / G Green / R Red / B	Badger

7. After you connect all three color wires, read the encoder register to ensure proper connections, and the receptacle / MIU is functioning properly.

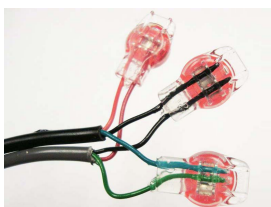

Figure 13: Three Color Wires Connected



Figure 14: Splice Tube

8. Take all three connected Scotchloks and push them into the splice tube until fully covered by the silicone grease.

9. Separate the gray wires, and place in the slots on each side of the splice tube.



Figure 15: Gray Wires in Slot



Figure 16: Cover in Place

10. Snap the cover closed to finish the installation.

4: Installation Instructions for Networked Receptacle / Dual Port MIUs



Enhanced R900 v4 MIUs are not dual port capable. These instructions only apply to v3 MIUs.

The Dual Port R900 and R450 MIUs work with Neptune ProRead™, E-CODER®[®], and ProCoder registers. Each register must be programmed in RF Network mode prior to installation.

- E-CODER and ProCoder registers cannot be programmed while connected together in a network. Each register must be programmed separately prior to making the network connection.



- The designations HI and LO are Neptune designations for the high (HI) flow or turbine side of the compound, and the low (LO) flow or disc side of the compound.
- The settings can also be used to designate the primary (HI) and secondary (LO) meters in a dual set application.

Programming the HI Register

To complete the following steps, use the Neptune Field Programmer to select the ProRead Program tab for programming.

1. Select **RF Compound HI** format.
2. Match the **Connectivity 2W**.
3. Match the **Dial Code 65**.
4. Type the appropriate register ID.



Figure 17: HI Register

5. Program the register.
6. Read or query the register to confirm correct programming. See Figure 17.

Programming the LO Register

Use the Neptune Field Programmer to select the ProRead Program tab for programming.

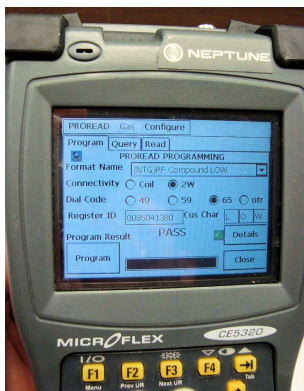

Figure 18: LO Register

1. Select **RF Compound LO** format.
2. Match the **Connectivity 2W**.
3. Match the **Dial Code 65**.
4. Type the appropriate register **ID**.
5. Program the register.
6. Read or query the register to confirm correct programming.

5: Wiring Networked Registers

Complete the following steps to wire networked registers.

1. Connect each color wire with the appropriate color wire from the pigtail and both registers, until all three colors have been successfully connected. See Figure 19.

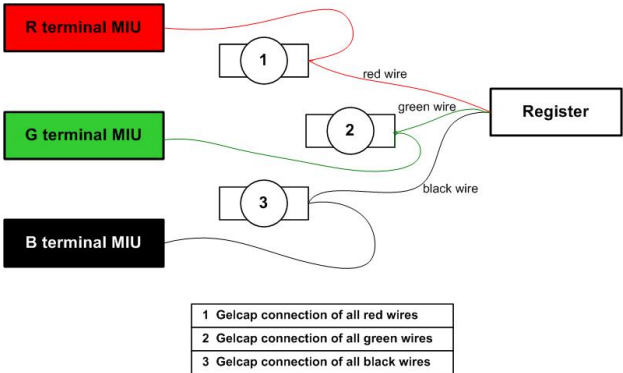

Figure 19: Interconnection of Like Terminals



- Remove any bare or non-insulated wire. Make sure that you only insert insulated wires into the splice connector.
- Observe proper polarity when wiring the registers so that all terminals are interconnected with wires of the same color: red, black, or green.

2. Proceed to "How to Read" on page 13.

6: Crimping Tool Manufacturers

To apply the Scotchlok™ connectors, Neptune requires the use of a proper crimping tool. Table 2 shows a list of various manufacturers and model numbers.



To reduce fatigue, use a tool within each splicing group with the highest mechanical advantage indicated within the parentheses ().

Table 2: Proper Crimping Tools

Manufacturer	Manufacturer's Model Number
3M	E-9R (10:1) — To reduce fatigue, use a tool within each splicing group with the highest mechanical advantage indicated within the parentheses (). E-9BM (10:1) E-9C/CW (7:1) E-9E (4:1) E-9Y (3:1)
Eclipse Tools	100-008



Use of normal pliers or channel locks is highly discouraged because they do not apply even pressure and can result in an improper connection.

7: How to Read

It is important to become familiar with the information available from the register.



Figure 20: Reading the ProCoder™

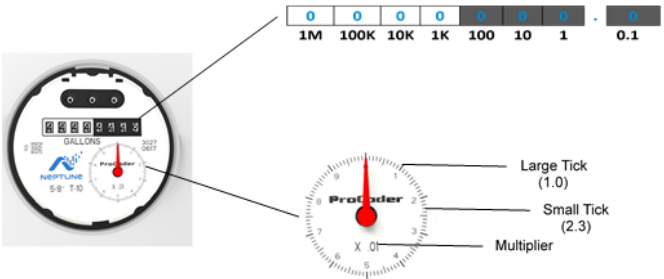

Figure 21: ProCoder™ Sweep Hand

The sensitive sweep hand provides a visual representation of extreme low flows as well as reverse flow. Depending on the size and type of ProCoder™ register, a specific multiplier is present. This multiplier, along with the current position of the sweep hand, provides additional digits of resolution that are especially useful for testing.



For further information on reading the ProCoder sweep hand, see the Product Support Document entitled *How to Read the Neptune ProCoder Register*.

8: Common Causes of Leaks

Leaks can result from various circumstances. To better help you identify a possible leak, Table 3 contains some common causes of leaks.

Table 3: Possible Leaks

Possible Cause of Leak	Intermittent Leak	Continuous Leak
Outside faucet, garden or sprinkler system leaking	✓	✓
Toilet valve not sealed properly	✓	✓
Toilet running		✓
Faucet in kitchen or bathrooms leaking	✓	✓
Ice maker leaking		✓
Soaker hose in use		✓
Leak between the water meter and the house		✓

Table 3: Possible Leaks (continued)

Possible Cause of Leak	Intermittent Leak	Continuous Leak
Washing machine leaking	✓	✓
Dishwasher leaking	✓	✓
Hot water heater leaking		✓
Watering yard for more than eight hours	✓	✓
Continuous pet feeder		✓
Water-cooled air conditioner or heat pump	✓	✓
Filling a swimming pool		✓
Any continuous use of water for 24 hours		✓

9: How to Tell if Water is in Use

To determine if water is in use, complete the following steps.

1. Look at the mechanical sweep hand.
2. Determine which of the following conditions exist.





Table 4: Determining if Water in Use

If...	Then...
The sweep hand is moving slowly in a clockwise direction	Water is running very slowly
The sweep hand is moving quickly	Water is running
The sweep hand is not moving	Water is not running
The sweep hand is moving counter-clockwise	Backflow is occurring

10: What to Do if There is a Leak

Refer to the following checklist if there is a leak.

Table 5: Checklist for Leaks

	Check all faucets for possible leaks.
	Check all toilets and toilet valves.
	Check the ice maker and water dispenser.
	Check the yard and surrounding grounds for a wet spot or indication of a pipe leaking.

11: If a Continuous Leak is Repaired

If a continuous leak is found and repaired, complete the following steps.

1. Use no water for at least 15 minutes.
2. Check the sweep hand.
If the sweep hand is not moving, then a continuous leak is no longer occurring.

12: If an Intermittent Leak is Repaired

If an intermittent leak is found and repaired, complete the following steps.

1. Check the sweep hand after at least 24 hours.
If the leak has been correctly repaired, the sweep hand does not move.
2. Refer to the following table which describes the standard functions of the ProCoder™ flags.

Table 6: ProCoder™ Flags

(When connected to an R900® MIU)

Backflow Flag (Resets After 35 Days)

Based on reverse movement of the eighth digit, the eighth digit is variable based on the meter size.

No backflow event	Eighth digit reversed less than one digit
Minor backflow event	Eighth digit reversed more than one digit up to 100 times the eighth digit
Major backflow event	Eighth digit reversed greater than 100 times the eighth digit

Leak Status Flag

Based on total amount of 15-minute periods recorded in the previous 24-hour period.

No leak	Eighth digit incremented less than 50 of the 96 15-minute intervals
---------	---

Table 6: ProCoder™ Flags (continued)

(When connected to an R900® MIU)

Backflow Flag (Resets After 35 Days)	
Intermittent leak	Eighth digit incremented in 50 of the 96 15-minute intervals
Continuous leak	Eighth digit incremented in all of the 96 15-minute intervals
Consecutive Days with Zero Consumption Flag (Resets After 35 Days)	
Number of days the leak status was at a minimum value	

13: Contact Information

Within the United States, Neptune Customer Support is available Monday through Friday, 7:00 A.M. to 5:00 P.M. Central Standard Time, by telephone, email, or fax.

By Phone

To contact Neptune Customer Support by phone, complete the following steps.

1. Call **(800) 647-4832**.
2. Select one of the following options:
 - Press **1** if you have a Technical Support Personal Identification Number (PIN).
 - Press **2** if you do not have a Technical Support PIN.
3. Enter the six-digit **PIN** and press **#**.
4. Select one of the following options:
 - Press **2** for Technical Support.
 - Press **3** for maintenance contracts or renewals.
 - Press **4** for Return Material Authorization (RMA) for Canadian Accounts.

You are directed to the appropriate team of Customer Support Specialists. The specialists are dedicated to you until the issue is resolved to your satisfaction. When you call, be prepared to give the following information.

- Your name and utility or company name.
- A description of what occurred and what you were doing at the time.
- A description of any actions taken to correct the issue.

By Fax

To contact Neptune Customer Support by fax, send a description of your problem to **(334) 283-7497**.

Please include on the fax cover sheet the best time of day for a customer support specialist to contact you.

By Email

To contact Neptune Customer Support by email, send your message to **support@neptunetg.com**.

Notes



Neptune Technology Group Inc.

1600 Alabama Highway 229
Tallassee, AL 36078
USA Tel: (800) 633-8754
Fax: (334) 283-7293

Neptune Technology Group

(Canada) Ltd.
7275 West Credit Avenue
Mississauga, Ontario L5N 5M9
Canada Tel: (905) 858-4211
Fax: (905) 858-0428

Neptune Technology Group Inc.

Avenida Ejercito Nacional No 418
Piso 12, Despacho 1203
Colonia Polanco V Sección
C.P. 11560 Delegación, Miguel Hidalgo
Mexico D.F.
Tel: (55) 5203-5708, (55) 5203-4032,
(55) 5203-5294

Online
www.neptunetg.com

QI ProCoder 02.19 / Part No. 13706-001
©Copyright 2017 -2019
Neptune Technology Group Inc.
Neptune is a registered trademark of
Neptune Technology G9roup Inc.